

SYSTEMATIC QUALITY

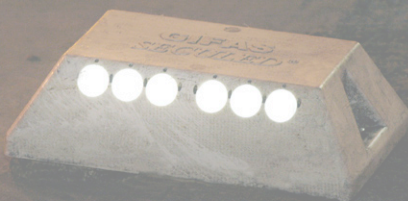

SecuLED



GIFAS
ELECTRIC

Introduction

Introduction



Page 3

Page 3

SecuLED

Product/System



Page 4

Pages 4-7

Technical data

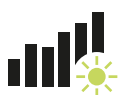

Page 5

Applications



Page 6

Product range



Page 7

Accessories

Control unit and remote control



Page 8

Pages 8-11

Power pack



Page 9

System components – mounting



Pages 10-11

LED guidance systems – for safe traffic routing



SecuLED

Our product line of optical guidance devices is applicable in tunnels, roundabouts or on the road in general.

We have detailed information, documentation, certificates for our system MarkLED which we would be appreciate to send if you are interested.

Why optical guidance systems?

An optical guidance device improves recognition of lanes or obstacles, particularly during times of poor visibility (at night, fog, etc.) as well as vulnerable traffic areas such as tunnels, curves, roundabouts or traffic islands. The signals provide a very high degree of safety for traffic.

The system complies with current regulations (BAST Germany, FEDRO Switzerland e.g.), and are continous EMC-approved, which means, that the system functions with cables/wires and is non-inductive, so electromagnetic fields are excluded.

The wired systems are installed directly in the road surface. However, it is important that the installation area is not constantly driven over.

Our recess-mounted lamps are compatible with all GIFAS systems. They complement each other ideally and require the same system components, such as a control unit, feeder cable, etc.

All GIFAS systems can be dimmed across a continuous scale using the control unit or remote control.

Your benefits at GIFAS

- EMC-approved, no inductive interference
- quick and easy installation
- latest LED technology, very low power consumption
- vandal-proof, reinforced synthetic material/V4A Investment casting
- dimmable by control unit
- interoperable with all LED guidance systems
- modular construction, low-maintenance
- often set in systems in different applications
- thereby high product- and application know-how

Our services

- many years of know-how, experienced Project Manager
- individual advice, also on site
- large standard range, individual solutions possible
- expert advice on installation and bringing into service
- creating CAD documents, voltage drop calculations and tunnel disposals
- own service team with professional equipment and many years of know-how



LED guidance systems in the FHS St. Gallen parking garage

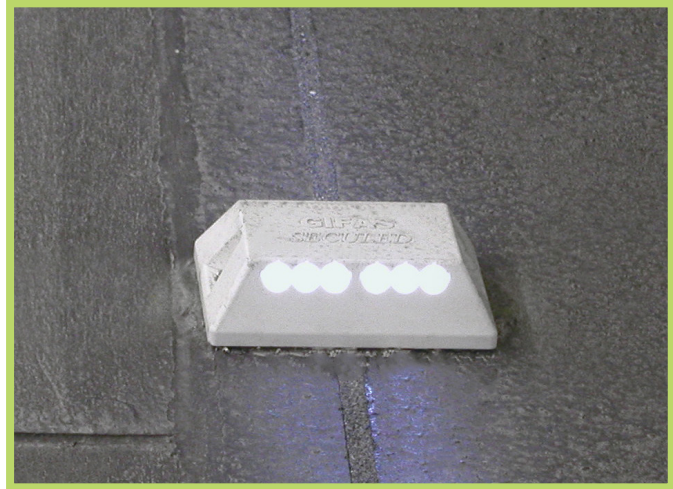

In contrast to the interruption-free current transmission, as in the MarkLED system, the conventional wired system is used for the SecuLED product series. The modules can be wired directly and can be looped. The two-part construction facilitates the maintenance and repair effort massively.

When laying highly flammable and heat-resistant cables, grooves must be milled into the pavement or introduced in pipes designed for new plants for subsequent installation.

The lamp modules are installed on the kerb in the immediate proximity of the edge of the road. The brightness of the lamp modules can be easily adjusted using the control units and can be controlled in all areas via an automatic light control system or direct control from the tunnel monitoring and control complex.

Mounting plate

The engineering design takes into account the various supply and mounting requirements.

Three enclosed cable sleeves, formed by way of injection moulding have been provided during manufacture for the cables to be fed through. The four attachment points have easily breakable seals over them.

The upper part of the mounting plate is sealed using two circular labyrinth seals. The upper part is attached in the threaded socket of the mounting plate using two captive screws.

SecuLED – cable connection

Upper part made of polyamide, fully fitted in accordance with selection, electronics encapsulated with freely accessible 2.5mm² spring-type clamps, with direct looping. Mounting plate made of polyamide, two surrounding O-ring seals, sealed cable inlets (for 2×2.5mm² cables), four sealed mounting holes of diameter 5mm.

Connection

The cables are connected by using spring-type clamps. A separate clamp is provided for the supply line and additional cables. The cables can be disconnected at any time by applying slight pressure to the release mechanisms.

Seals

The individual components have been engineered to ensure a high level of leak-tightness. Professional installation assumed.

Controls

The control units required for supplying and/or controlling the lamp modules are very small, require little space, and can usually be integrated into existing junction boxes or control cabinets. A small junction box can be mounted in a suitable location if required.

Product documentation

Installation instructions



Declaration of conformity



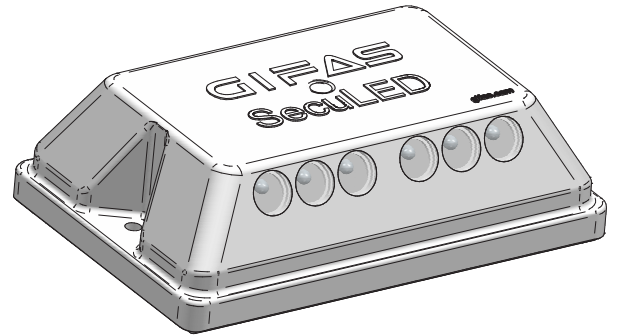

Technical data

Light colour	white (5.100K)
Light intensity	30 cd
Illuminant	12 LED
Operating life LED	50.000h
Protection category	IP67
Protection class	III
Operating voltage	24VDC (range 16-40VDC)
Power consumption	40mA
Dimensions (LxWxH)	178,4x118,0x53,5mm
Upper part	polyamide, white
Lower part	polyamide, white

 A detailed datasheet from system components is available on request.

One-components SecuLED

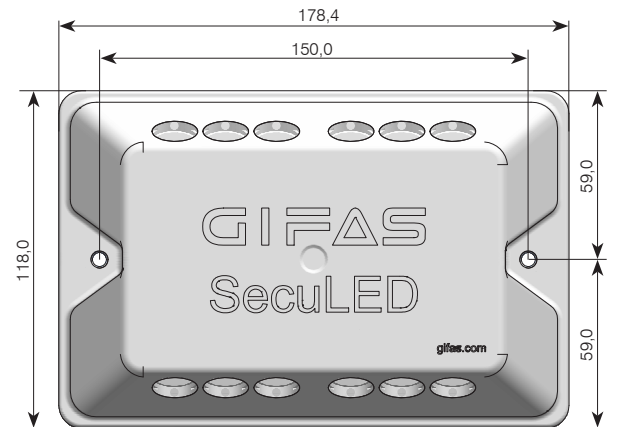
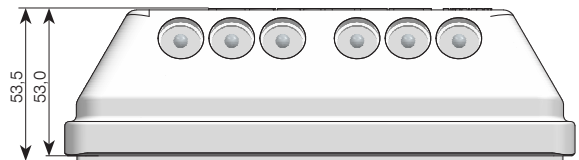
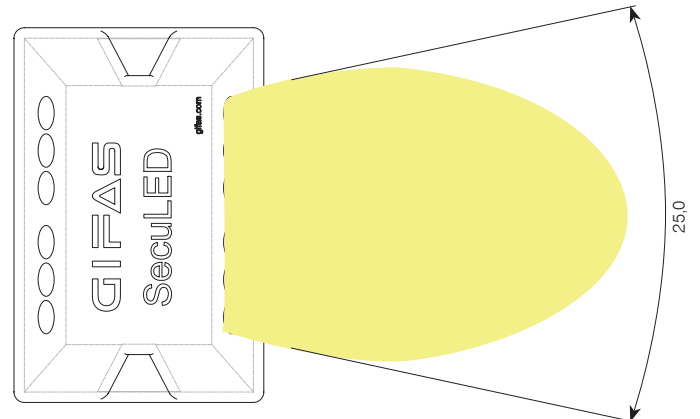
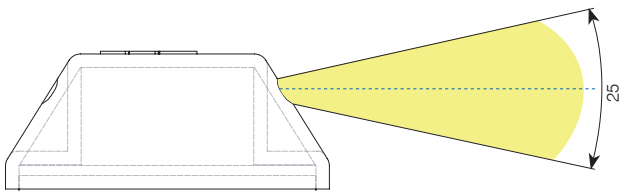

Diagram light emission





Tunnel Gubrist



Tunnel Gubrist



Tunnel St. Maurice, Valais



Tunnel St. Maurice, Valais



Cleaning tunnel



Cleaning tunnel



Product range SecuLED

EDP No.	Description
CH-860462	SecuLED light module 40mA/double-sided 6×white, 5.100K
860463	SecuLED light module 60mA/6×white, 5.100K/6×red, 625 nm
860464	SecuLED light module 80mA/double-sided 6×green, 525 nm
CH-860465	SecuLED light module 80mA/double-sided 6×blue, 470 nm
128522	System cable 2x2,5 mm ² wire color red/black, longitudinal water-tight and flame-retardant

Other versions on request

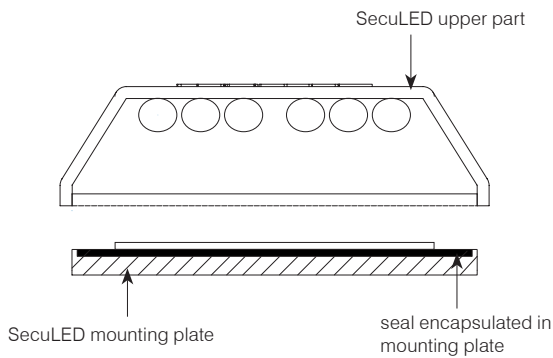

4-channel control unit

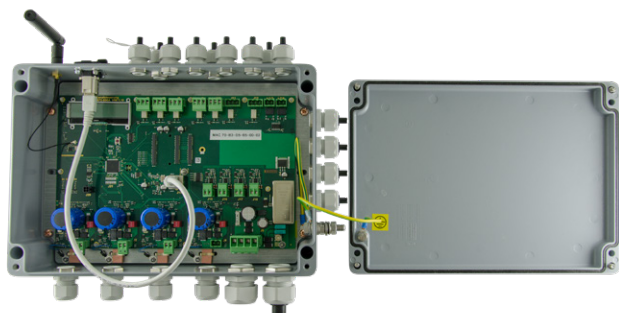

The control unit for all GIFAS systems is designed for 4 output lines. Each channel can be loaded with up to 10 A.

- **Supply:** A 230 VAC/24-48 VDC power supply device with a nominal output current of 40 A is installed upstream from the control unit.
- **Error messages:** Each channel has a relay with SPDT (potential free) assigned to the signaling of error messages.
- **External blinking contacts:** By default, two external flashing signals (24-60 VDC) can be connected and transferred to the outgoing lines (synchronisation with flashing signal).
- **Operating mode:** The control unit has 8 or 31 different modes of operation.
- **Failure rate:** By failure rate detection, the lights can be tested for their functionality. The control unit measures the total power consumption of the respective channel. If the power consumption drops to a preset value, the fault message can be detected via a changeover contact (potential-free).
- **Functions:** One of the following functions can be assigned to each channel in each mode:
 - Continuous lighting: 100%
 - Dimming: adjustable from 1-99%
 - Flash: adjustable from 0.1-9.9 Hz
 - Lightning: adjustable from 1-99 ms
 - Running light: running light direction, dimming 1-99%, Light duty cycle 100 ms-10 sek, delay in lighting 100 ms-10 sek, Switch-on delay 0-999 sek, duty cycle 0-999 sek
 - Off
- **Programming:** the control unit can be optionally parametrised and read out via the web interface or the optionally available radio programming unit.
 - Web interface: if the control unit is connected to the network via RJ45 Cat. 6a, all parameters can be set and read out via a web browser.
 - Radio programming unit: The parameters can also be set by the radio programming unit.

Technical data

Protection category	IP65
Rated power max.	1.920 VA
Input voltage	18-48 VDC
Supply current	40 A, 4 channels à 10 A
Power supply	external
Dimensions	330×230×110 mm

EDP No.	Description
860594	Control unit 4-channel IP65, 18-48 VDC, 4×10 A ready for installation in housing of cast aluminium 330×230×110 mm, excl. power pack

Remote control to 4-channel control unit



Programming device with menu guide for set-up, programming and status recognition of the control unit. Communication with the control unit occurs through radio.

All necessary functions can be set up and assigned through the menu structure. No special knowledge is required to operate it. The connection between the control unit and the programming device is bi-directional, i.e. the current settings can be transferred from one to the other.

The buttons «↑», «↓», «☒» and «✓» are used to navigate the system. The range is approx. 3 m.

The menu is available in 4 languages: German, English, French and Italian.

Technical data

Material	ABS
Protection category	IP40
Protection class	III
Radio frequency	2.4-2.525 GHz
Operating voltage	4.5 VDC, 3 pcs. batteries type AAA
Life of battery	> 1 year in standby mode
Dimensions (WxHxD)	73×140×32 mm
Colour	graphite grey similar to RAL 7024

EDP No.	Description
860460	Remote control complete for the control unit 4-channel

Power pack for control unit 4-channel



A 230VAC/24/36/48VDC power pack is installed upstream from the 4-channel control unit. The power pack is equipped with integrated protection against overloading and short-circuiting, with automatic or manual reset. The power pack conforms to CEE regulations and also has UL and/or CSA approval.

Technical data

Protection category	IP20 (with additional cover IP42)
Protection class	I
Input voltage	230 VAC (range 100 - 240 VAC)
Output voltage	24 / 36 / 48 VDC
Output current	10 / 20 A
Connections primary	screw terminals 4 mm ²
Connections secondary	screw terminals 4 mm ²
Status display	LED green
Installation	quick fastening for DIN rail 35 mm
Dimensions (W×H×D)	39×124×117 mm

A detailed datasheet on the power pack is available on request

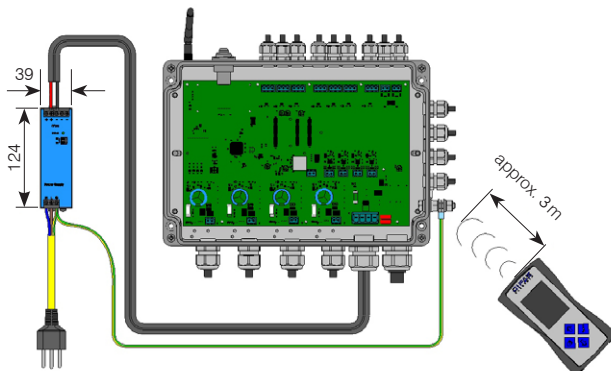

EDP No.	Description
92297	Power pack 230VAC/24VDC-10A/240W 39×124×117 mm
CH-136629	Power pack 230VAC/24VDC-20A/480W 65×124×127 mm
CH-192133	Power pack 230VAC/36VDC-6.7A/240W 39×124×127 mm

Other versions on request

Fire-proof junction boxes

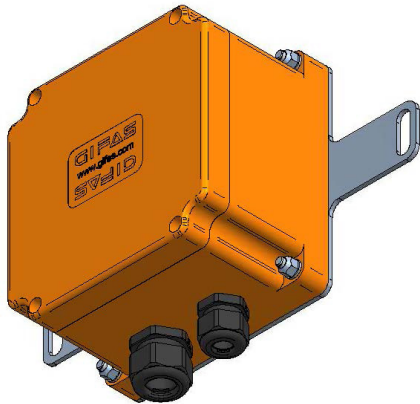

The safety cable must be connected from control center to the GIFAS system cable when connecting the signal units to the infrastructure. A special junction box is required for these connections. This can be installed in the cable trunks in the tunnel shoulder or at another suitable point. An E30/E60 junction box is usually required for this application. The size of junction box depends on the feed-in cable used as well as the number of outlets.

We will be pleased to advise you on a project-specific basis.

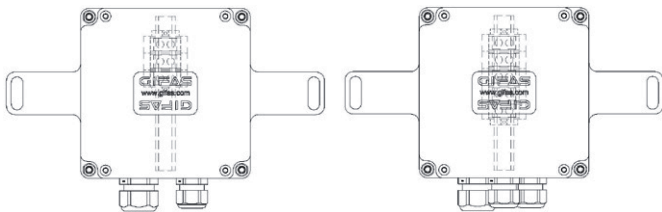

EDP-No. 207643

EDP-No. 208762

EDP No.	Description
CH-207643	Junction box polyester FE180/E30 type 3018, orange 160×160×100 mm, 7x10 mm ² , IP66/68
CH-208762	Junction box polyester FE180/E30 type 3018, orange 160×160×100 mm, 7x10 mm ² , IP66/68

Installation material

Protective hose

Depending on the type of installation, the system cable can also be conducted in a conduit (fluted, halogen-free).

We are glad to advise you for specific projects!



EDP-No. 90187



EDP-No. 128266

EDP No.	Description
90187	Conduit PP, Ø25/19 mm, flexible VE=100 m
CH-128266	Protective hose PA6, Ø21,2/16,5 mm, flexible, VE=50 m UV resistance, operating range of temperature -40°C to 120°C, up to 150° for a short time 150°C

System profile

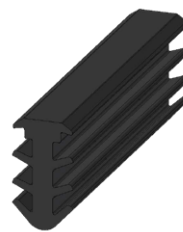

EDP-No. 107517

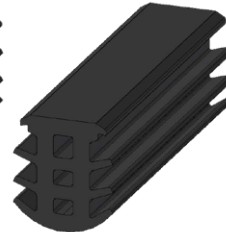

EDP-No. 140862

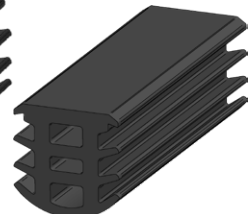

EDP-No. 155809

The milled groove of the optical guidance system must be sealed against environmental conditions. A simple and low-cost solution is to use the halogen-free GIFAS system profile made of EPDM. This is inserted in the slot. It is self-locking and available in three different widths. A stable and smooth slot with slot widths of 6 -15 mm is the prerequisite for use.

Technical data

Material properties	halogen-free, no corrosive and toxic gases
Shore hardness A	70° ±5%
Special weight	1,23 kg/l
Elongation at break	237% DIN 53504
Breaking stress	11.2MPa DIN 53504
EDP-No. 116753:	
Exterior dimensions	9,3mm×17,1 mm
Groove width	6-8 mm
Nominal section	89 mm ²
Weight	109 kg/km
EDP-No. 140862:	
Exterior dimensions	14,5mm×17,1 mm
Groove width	10-11,2 mm
Nominal section	146 mm ²
Weight	177 kg/km
EDP-No. 155809:	
Exterior dimensions	17,35 mm×17,5 mm
Groove width	12-15 mm
Nominal section	171 mm ²
Weight	254 kg/km

EDP No.	Description
107517	Joint profile EPDM 70° Shore, for groove 6-8 mm 9,3×17,1 mm, black
CH-140862	Joint profile EPDM 70° Shore, for groove 10-11,2 mm 13×17,1 mm, black
CH-155809	Joint profile EPDM 70° Shore, for groove 12-15 mm 17,35×17,5 mm, black

Joint sealing compound



The recommended system sealing compound is heated to 160° – 180° C while being constantly mixed. The compound is applied using a spouted container or grouting lance. Excess compound must be removed by scraping once it has fully cooled.

Technical Data

Colour	black
Form of delivery	1 box with 24×cubes à 700 g
Sealing temperature	160° C - 180° C
Weight per unit volume	1.2g/cm³

EDP No.	Description
CH-208907	Sealing compound TOK-Melt N2 (1 box with 24×cubes à 700g)







CONTACT US



GIFAS
ELECTRIC

GIFAS ELECTRIC
Gesellschaft m.b.H.
Strass 2
5301 Eugendorf
AUSTRIA

 www.gifas.at
 verkauf@gifas.at
 +43 6225 / 7191 - 0
 +43 6225 / 7191 - 561
 +49 8654 404 2000

We reserve the right to make technical modifications. 11/2021/1.0